BC600XL Brush Chipper

Operator's Manual



Vermeer[®]

BC600XL_02_05

Serial No. 387 -

Order No. 105400X55

Cabled Assembly No. 163622832

Introduction

This manual explains the proper operation of your machine. Study and understand these instructions thoroughly before operating or maintaining the machine. Failure to do so could result in personal injury or equipment damage. Consult your Vermeer dealer if you do not understand the instructions in this manual, or need additional information.

The instructions, illustrations, and specifications in this manual are based on the latest information available at time of publication. Your machine may have product improvements and features not yet contained in this manual.

Vermeer Corporation reserves the right to make changes at any time without notice or obligation.

Operation instructions are included in the two Operator's Manuals provided with the machine. The tethered (cabled) manual must remain attached to the machine for ready reference. Store it in the manual storage box when not in use.

Lubrication and maintenance procedures are in the Maintenance Manual provided with the machine. Refer to it for all lubrication and maintenance procedures.

Additional copies of the manuals are available from your dealer. Use the reorder number on the front cover to order additional manuals.

Copies of this manual are available in Spanish from your dealer.
Se dispone de ejemplares de este manual en español.

NOTICE TO OWNER

You are requested to notify Vermeer Corporation when you have purchased a **used** Vermeer machine. Notify the Customer Data Department by telephone: 800-829-0051 or 641-628-3141; email: customerdata@vermeercorp.com; internet: www.vermeercorp.com or www.vermeercorp.com; or letter: Customer Data Dept., Vermeer Corporation, PO Box 200, Pella IA 50219 USA. Upon request, an owner of a used Vermeer machine will receive one free set of Operator's, Maintenance and Parts manuals.

Introduction

BC600XL Brush Chipper

BC600XL Brush Chipper

PERKINS is a trademark of Varity Holdings Ltd, United Kingdom.

KOHLER is a trademark of Kohler Company.

VERMEER, VERMEER Logo, and AUTOFEED II are registered trademarks of Vermeer Manufacturing Company.

TRADEMARKS

NOTE: Right and left sides of the machine are determined by facing in the direction of forward travel.

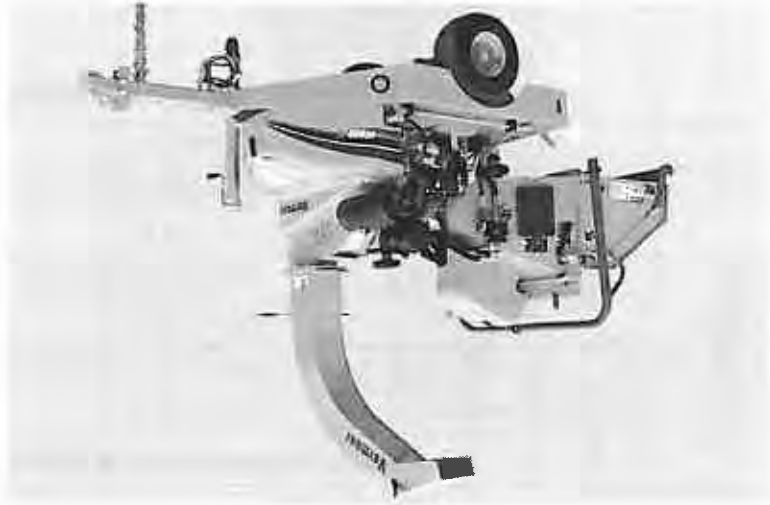

EV PATENTS

This machine may be covered by one or more of the following patents:

EP 1 215 991	US 5,893,262	US 6,840,471	US 7,204,442
US 4,848,423	US 5,950,942	US 6,843,435	US 7,213,779
US 5,588,474	US 6,014,996	US 6,978,955	US 7,232,083
US 5,657,803	US 6,138,932	US 7,011,258	US D 308,682
US 5,692,548	US 6,412,715	US 7,040,558	
US 5,692,549	US 6,422,495	US 7,044,409	
US 5,845,689	US 6,446,889	US 7,077,345	

This machine may be covered by one or more of the following licensed patents:

US 4,932,196
US 4,976,095
US 5,893,262
US 5,941,768
US 6,931,826

(Other U.S. and foreign patents pending.)

Introduction

2-05

2-04

BC600XL Brush Chipper

VERMEER NEW INDUSTRIAL EQUIPMENT LIMITED WARRANTY

(EFFECTIVE OCTOBER 1, 2008)

WARRANTY PERIOD: 12 Months / 1000 Hours

Vermeer Corporation (hereinafter "Vermeer") warrants each new Industrial product of Vermeer's manufacture to be free from defects in material and workmanship, under normal use and service for one (1) full year after initial purchase/retail sale or 1000 operating hours, whichever occurs first. This Limited Warranty shall apply only to complete machines of Vermeer's manufacture, parts are covered by a separate Limited Warranty. **EQUIPMENT AND ACCESSORIES NOT OF VERMEER'S MANUFACTURE ARE WARRANTED ONLY TO THE EXTENT OF THE ORIGINAL MANUFACTURER'S WARRANTY AND SUBJECT TO THEIR ALLOWANCE TO VERMEER ONLY IF FOUND DEFECTIVE BY SUCH MANUFACTURER.**

EXTENDED WARRANTY OPTIONS ARE AVAILABLE FOR PURCHASE.

WARRANTY TERMS

During the Limited Warranty period specified above, any defect in material or workmanship in any warranted item of Vermeer Industrial Equipment not excluded below shall be repaired or replaced at Vermeer's option without charge by any authorized independent Vermeer dealer. The warranty repair or replacement must be made by a Vermeer independent authorized dealer at the dealer's location. Vermeer will pay for replacement parts and such authorized dealer's labor in accordance with Vermeer's labor reimbursement policy. Vermeer reserves the right to supply remanufactured replacement parts as it deems appropriate.

RETAIL PURCHASER RESPONSIBILITY: This Limited Warranty requires proper maintenance and periodic inspections of the Industrial Equipment as indicated in the Operator's/Maintenance Manual furnished with each new Industrial Equipment. The cost of routine or required maintenance and services is the responsibility of the retail purchaser. The retail purchaser is required to keep documented evidence that these services were performed.

This Vermeer New Industrial Equipment Limited Warranty may be subject to cancellation if the above requirements are not performed.

Vermeer Industrial Equipment with known failed or defective parts must be immediately removed from service.

BC600XL Brush Chipper

Introduction

EXCLUSIONS AND LIMITATIONS

The warranties contained herein shall NOT APPLY TO:

- (1) Any defect which was caused (in Vermeer's sole judgment) by other than normal use and service of the Industrial Equipment, or by any of the following: (i) accident (ii) misuse or negligence (iii) overloading (iv) lack of reasonable and proper maintenance (v) improper repair or installation (vi) unsuitable storage (vii) non-Vermeer approved alteration or modification (viii) natural calamities (ix) vandalism (x) parts or accessories installed on Industrial Equipment which were not manufactured or installed by Vermeer authorized dealers (xi) the elements (xii) collision or other accident.
- (2) Any Industrial Equipment whose identification numbers or marks have been altered or removed or whose hourmeter has been altered or tampered with.
- (3) Any Industrial Equipment which any of the required or recommended periodic inspection or services have been performed, using parts not manufactured or supplied by Vermeer or meeting Vermeer Specifications including, but without limitation, engine tune-up parts, engine oil filters, air filters, hydraulic oil filters, and fuel filters.
- (4) New Industrial Equipment delivered to the retail purchaser in which the warranty registration has not been completed and returned to Vermeer within ten (10) days from the date of purchase.
- (5) Any defect which was caused (in Vermeer's sole judgment) by operation of the Industrial Equipment not abiding by standard operating procedures outlined in the Operator's Manual.
- (6) Engine, battery, and tire Limited Warranties and support are the responsibility of the respective products manufacturer. Transportation costs, if any, of transporting to the Vermeer dealer. Freight costs, if any, of transporting replacement parts to the Vermeer dealer.
- (8) The travel time of the Vermeer dealer's service personnel to make a repair on the retail purchaser's site or other location.
- (9) In no event shall Vermeer's liability exceed the purchase price of the product,
- (10) Vermeer shall not be liable to any person under any circumstances for any incidental or consequential damages (including but not limited to, loss of profits, out of service time) occurring for any reason at any time.
- (11) Diagnostic and overtime labor premiums are not covered under this Limited Warranty Policy. Oils and fluids are not covered under this Limited Warranty.

Introduction

BC600XL Brush Chipper

- (12) Depreciation damage caused by normal wear, lack of reasonable and proper maintenance, failure to follow operating instructions, misuse, lack of proper protection during storage.
- (13) Accessory systems and electronics not of Vermeer's manufacture are warranted only to the extent of such manufacturer's respective Limited Warranty if any.
- (14) Downhole toolage is not covered under this warranty.
- (15) Wear items which are listed by product group as follows:

ENVIRONMENTAL: Bearing Seals, Bearings, Belts, Brake Pads, Bolts/Torqued Parts, Chain, Clutches, Clutch Components, Curtains, Cutter Wheels, Discharge Conveyor Belts, Fuel Filters, Hammers, Hoses, Infred Conveyor Belts, Infred Conveyor Chains, Knives, Oil Filters, Pockets, Rods, Rollers, Rotor Plates, Screens, Service Items, Shear Bar/Bedknife, Sprockets, Teeth, Wear Blocks, Wear Strips.

TRACK: Base Plates, Boom Wear Items, Buckets, Cable Finders, Conveyor Belts, Clutches, Cups, Digging Chain, Digging Rims, Drums, End Idler, Flashings, Pins and Bushings, Pivot Rings, Plastic Wear Strips, Rooter Bands, Scraper Knives, Sprockets, Teeth, Track Chain, Trench Cleaner (Crumber), Trip Cleaners, Truck Rollers, Wear Plates.

TRENCHLESS: Brushes, Clamping Vise Parts, Dies, Drive Chuck, Earth Stakes, Fan Belts, Jaws, Leaf Chain, Lights On Light Kits, Packing Assemblies, Rod, Rod Loader Parts, Rollers, Tooling, Track Chain, Track Guides, Track Idlers, Track Pads, Track Sprockets, Valve Seats, Wear Bars, Wear Blocks, Water Hoses, Water Swivels, Wear Bars.

UTILITY PRODUCTS: Augers, Belts, Bearings, Booms, Brake Pads, Bucket, Bushings, Chains, Clutches, Conveyor Belts, End Rollers, Flashings, Pins, Pivot Rings, Plow Blades, Rubber Shielding, Sprockets, Teeth, Tires, Track Chain, Track Idlers, Track Sprockets, Trench Cleaner (Crumber).

PARTS WARRANTY:

Parts replaced in the warranty period will receive the balance of the first year New Industrial Equipment Limited Warranty, during the first (12) months or 1000 hours, whichever comes first. Replacement parts after the original machine warranty, are warranted to be free from defects of material for ninety (90) days or the part will be repaired or replaced, without labor coverage for removal and reinstallation.

MANUFACTURED BY:
VERMEER CORPORATION
Pella, Iowa 50219 USA

EXCLUSIONS OF WARRANTIES: EXCEPT FOR THE WARRANTIES EXPRESSLY AND SPECIFICALLY MADE HEREIN, VERMEER MAKES NO OTHER WARRANTIES, AND ANY POSSIBLE LIABILITY OF VERMEER HEREUNDER IS IN LIEU OF ALL OTHER WARRANTIES, EXPRESS, IMPLIED, OR STATUTORY, INCLUDING, BUT NOT LIMITED TO, ANY WARRANTIES OF MERCHANTABILITY OR FITNESS FOR A PARTICULAR PURPOSE. VERMEER RESERVES THE RIGHT TO MODIFY, ALTER AND IMPROVE ANY PRODUCT WITHOUT INCURRING ANY OBLIGATION TO REPLACE ANY PRODUCT PREVIOUSLY SOLD WITH SUCH MODIFICATION. NO PERSON IS AUTHORIZED TO GIVE ANY OTHER WARRANTY, OR TO ASSUME ANY ADDITIONAL OBLIGATION ON VERMEER'S BEHALF.

NO DEALER WARRANTY: The selling dealer makes no warranty of its own and the dealer has no authority to make any representation or promise on behalf of Vermeer or to modify the terms or limitations of this warranty in any way.

Receiving and Delivery Report

DEALER PREP

Check or perform the following:

Engine

- Check engine oil level.
- Check battery electrolyte level and charge.
- Check air cleaner condition.
- Check coolant level and antifreeze concentration - Perkins engine.
- Check engine operation.
- Check that all gauges and indicators work correctly.
- Check that exhaust system is mounted correctly and tight.

Hydraulics

- Check hydraulic fluid level.
- Check all hydraulic components for leaks or damage.
- Check control levers for proper operation.
- Check *Upper Feed Control Bar* for proper function.
- Check *Lower Feed Stop Bar* system for proper operation.

General

- Check machine for shortage or damage in transit.
- Check installation and condition of all shields.

BC600XL Brush Chipper

Receiving and Delivery Report !

- ___ Check machine for proper lubrication.
- ___ Check condition of all safety signs and operating decals.
- ___ Check all phases of operation.
- ___ Check for loose hardware.
- ___ Check wheel lug nuts torque (refer to the *Specifications* section in the *Maintenance Manual*.)
- ___ Check air pressure of tires (refer to the *Specifications* section in the *Maintenance Manual*.)
- ___ Check operation of the brakes (Optional Electric Brakes).
- ___ Check operation of breakaway system (Optional Electric Brakes).
- ___ Check operation of highway lights.
- ___ Check that safety towing chain is properly installed.
- ___ Check that towing hitch is properly attached to machine and mounting hardware is torqued to 120 ft-lb (163 Nm).
- ___ Check drive belt for proper tension.
- ___ Check belt tightener for proper function.
- ___ Check torque on shear bar mounting bolts (refer to the *Maintenance - 50 Service Hours or Weekly Section* in the *Maintenance Manual*).
- ___ Check torque on cutter knife bolts (refer to the *Maintenance - 50 Service Hours or Weekly Section* in the *Maintenance Manual*).
- ___ Check operation of feed roller controls.
- ___ Check operation of the AutoFeed II control system.

Feed System

!! Receiving and Delivery Report

DELIVERY

Check and perform the following with the customer:

Brush Chipper

- Review all sections of the *Operator's Manual*.
- Grease or oil all lubrication points.

Review of Operation

- Review and demonstrate with the customer the various aspects of brush chipper operation:
- overall explanation of how the brush chipper works
- brush chipper safety
- preparing the brush chipper for operation

BC600XL Brush Chipper

Receiving and Delivery Report !!!

DEALER/CUSTOMER INFORMATION

dealer

address

city

state/province

zip/postal code

country

owner

address

city

state/province

zip/postal code

country

BC600XL Brush Chipper

Receiving and Delivery Report v



PERKINS ENGINE - RECORD

Serial Number _____

Model Number _____

MACHINE IDENTIFICATION NUMBERS - RECORD

VIN Number _____

Model Number _____

KOHLER ENGINE - RECORD

Serial Number _____

Model Number _____



BC600XL Brush Chipper

Prepare Brush Chipper..... 40-4

Clean Flammable Materials from Machine..... 40-4

Discharge Chute..... 40-5

Feed Table..... 40-7

Feed Control Bars - Check..... 40-8

Backup Marker Flags - Install..... 40-9

Operating the Brush Chipper..... 50-1

Cutter Shaft - Check..... 50-1

Belt Tightener - Engage..... 50-1

Feed Roller Operation..... 50-2

Upper Feed Control Bar..... 50-3

Lower Feed Stop Bar..... 50-3

Feed Roller - Engage..... 50-5

AutoFeed II Control Operation (Option)..... 50-5

Chip Material..... 50-6

Feeding Tips..... 50-6

Material Size..... 50-6

Plugs or Stalls..... 50-6

Finishing..... 50-7

Removing Plugs from Brush Chipper..... 51-1

Feed Roller - Unplug..... 51-1

Cutter Disc Rotation - Check..... 51-3

Cutter Disc Housing - Open..... 51-4

Cutter Disc - Unplug..... 51-5

Maintenance Intervals..... 60-1

Hourmeter - Check for Maintenance Interval..... 60-1

Machine - Grease..... 60-1

Safety Signs..... 60-2

Maintenance Manual..... 60-2

Maintenance Intervals..... 60-3

Knife/Cutter Disc Maintenance..... 61-1

Knife Removal..... 61-2

Cutter Disc Inspection..... 61-3

Knife Sharpening..... 61-4

Knife Installation..... 61-4

Section 10: Safety Messages

General safety messages appear in this Safety Messages section. Specific safety messages are located in appropriate sections of the manual where a potential hazard may occur if the instructions or procedures are not followed.

A signal word "DANGER", "WARNING", or "CAUTION" is used with the safety alert symbol. Safety signs with signal word "DANGER", "WARNING", or "CAUTION" are located near specific hazards.

DANGER Indicates a hazardous situation which, if not avoided, will result in death or serious injury.

WARNING Indicates a hazardous situation which, if not avoided, could result in death or serious injury.

CAUTION Indicates a hazardous situation which, if not avoided, could result in minor or moderate injury.

SAFETY SYMBOL EXPLANATION



This is the safety alert symbol. This symbol is used in combination with an exclamation mark or other symbols to alert you to the potential for bodily injury or death.



WARNING: Read Operator's Manual and safety signs before operating machine.

10-2 Safety Messages

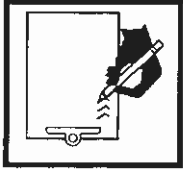

WARNING: Check machine before operating. Machine must be in good operating condition and all safety equipment installed and functioning properly.



WARNING: Wear personal protective equipment. Dress properly. Refer to *Preparing Brush Chipper and Work Area*, page 40-1.

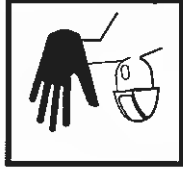

WARNING: Keep spectators away.



WARNING: Engine exhaust can asphyxiate. Operate only outdoors.

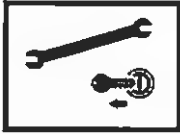

WARNING: Use Shutdown Procedure before servicing, cleaning, repairing or transporting machine. Refer to the *Shutdown Procedure*, page 23-1, for instructions.



WARNING: Pressurized fluid can penetrate body tissue and result in serious injury or death. Leaks can be invisible. Keep away from any suspected leak. Relieve pressure in the hydraulic system before searching for leaks, disconnecting hoses, or performing any other work on the system. If you must pressurize the system to find a suspected leak, use an object such as a piece of wood or cardboard rather than your hands. When loosening a fitting where some residual pressure may exist, slowly loosen the fitting until oil begins to leak. Wait for leaking to stop before disconnecting the fitting. Fluid injected under the skin must be removed immediately by a surgeon familiar with this type of injury.

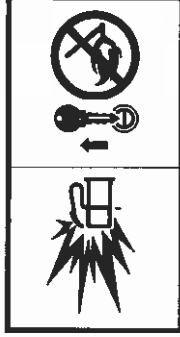

WARNING: Fuel and fumes can explode and burn.

Shut off engine before refueling. No flame. No smoking.

WARNING: Failure to follow any of the preceding safety instructions or those that follow within this manual, could result in serious injury or death. This machine is to be used only for those purposes for which it was intended as explained in this Operator's Manual.



Close all shields before starting.



WARNING: Moving parts can crush fingers.



Allow engine to cool before opening radiator cap.



WARNING: Hot fluid under pressure can scald.



Section 21: Controls

ENGINE CONTROLS - PERKINS (EU MACHINES ONLY)

(1) Throttle

With center button depressed

Pull knob outincrease RPM

Push knob in decrease RPM

(2) Ignition Switch

2nd position clockwise..... engine start

1st position clockwise engine on

Center position engine off

Counter-clockwise..... glow plugs on

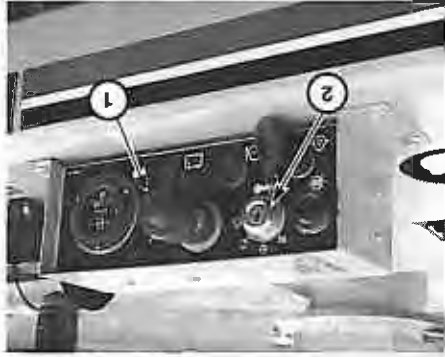

ENGINE MONITORS - PERKINS (EU MACHINES ONLY)

(1) Oil Pressure Warning Light
Onoil pressure low



(2) Coolant Temperature Warning Light



Oncoolant hot
NOTE: The engine will shut down 6 seconds after either light (1) or (2) comes on.

(3) Alternator Warning Light



On not charging

(4) Hourmeter



Records total machine operation time.

(5) Preheat Indicator



With ignition switch in GLOW PLUG position:
Dark heating
Dull red glow engine ready to start
NOTE: Heating the glow plugs takes approximately 20-30 seconds.
Do not continue heating them once the indicator shows a dull red glow; damage to glow plugs may result.

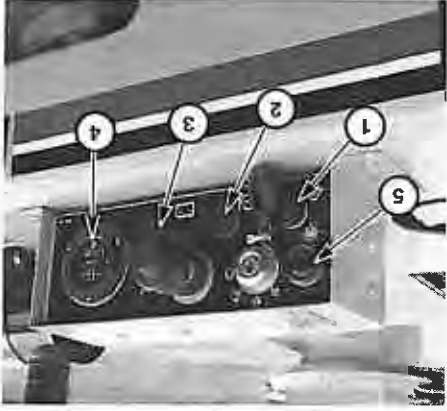



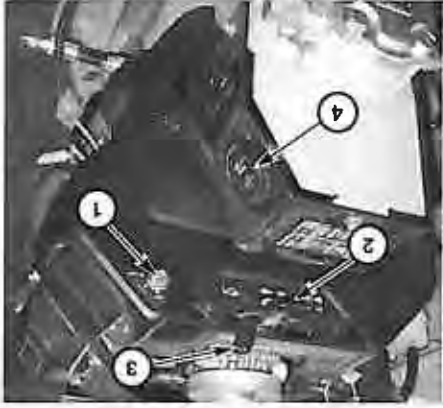

ENGINE CONTROLS - KOHLER

BC600XL Brush Chipper

Controls 21-3



	<p>(1) Ignition Switch</p> <p>Center position engine off</p> <p>1st position clockwise engine on</p> <p>Fully clockwise engine start</p>
	<p>(2) Throttle</p> <p>Push left increase RPM</p> <p>Pull right decrease RPM</p>
	<p>(3) Choke</p> <p>Push left close choke</p> <p>Pull right open choke</p>
	<p>(4) Hourmeter</p> <p>Records total machine operation time.</p>

CUTTER DISC CONTROLS

(1) Belt Tightener

Pull engaged cutter wheel

Push disengage cutter wheel

NOTE: Refer to *Operating the Brush Chipper*, page 50-1, for instructions on engaging the clutch.

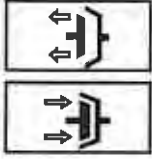

FLUID MONITORS

(1) Hydraulic Fluid Level Gauge

Correct fluid level is when marker is in the green zone.



FEE D ROLLER CONTROLS

(1) Upper Feed Control Bar

Rear position..... feed roller STOP

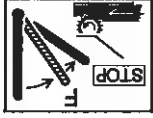

Second position from rear..... feed roller FORWARD

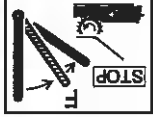

Third position from rear..... feed roller STOP

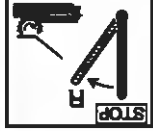

Forward position..... feed roller REVERSE

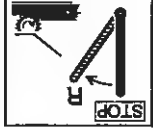

NOTE: *Upper Feed Control Bar* is spring-returned from REVERSE to center STOP position and must be held to operate feed rollers in REVERSE.

NOTE: Feed rollers will not move unless:

- engine speed is at high RPM (if equipped with AutoFeed II control system)
- *Lower Feed Stop Bar* is reset
- *Upper Feed Control Bar* is in forward or reverse feeding position.

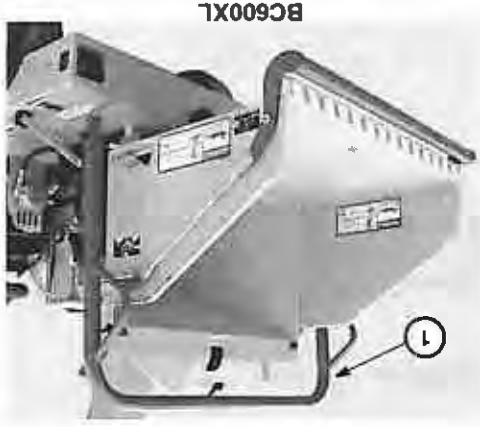

BC600XL



BC600XL European



BC600XL European



BC600XL European

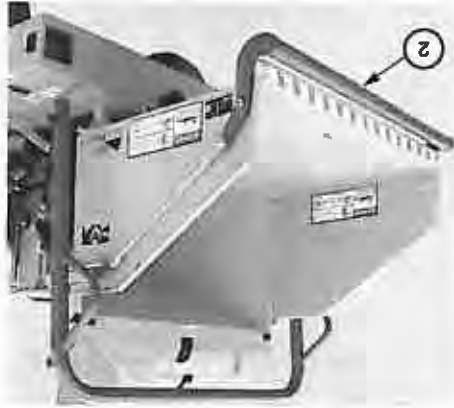

BC600XL

(2) Lower Feed Stop Bar

Bar pressed..... feed roller stop



To reset: Pull Reset Lever (4) (BC600XL); or push Reset Button (3) (BC600XL European).

(3) Reset Button - BC600XL European Only

Press briefly to restart feed roller after Lower Feed Stop Bar (2) has been tripped or Upper Feed Control Bar (1) has been moved to STOP position. Amber light (A) on switch remains lit until Reset Button is pressed, then light goes off.



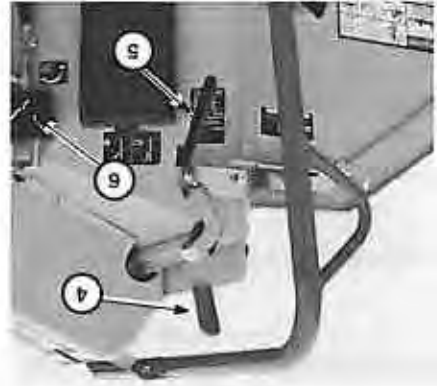

(4) **Reset Lever (located on both sides of infeed chute) - BC600XL Only**
 Press forward.....feed roller stopped
 Pull back.....feed roller operational



Push down Normal sensitivity
 NOTE: Feed roller stops when stop bar is pushed a shorter distance.



Pull up Reduced sensitivity
 NOTE: Feed roller stops when stop bar is pushed a farther distance.



NOTE: Each time the feed table is raised to transport position, the lower feed stop bar system defaults to Normal sensitivity.

(6) **Feed Roller Speed Control**



Clockwise increase feed roller speed



Counterclockwise.....decrease feed roller speed

DISCHARGE CHUTE CONTROLS

(1) Chute Deflector Lock (two levers)

Counterclockwise..... loosen lock
 Clockwise..... tighten lock

(2) Chute Deflector Adjustment

Raise deflector..... increase chip throwing distance
 Lower deflector..... decrease chip throwing distance
 NOTE: To reach chute deflector and locks, position chute over tongue, and stand on slip-resistant material in front of tool box.

(3) Transport Lock - Red Locking Bar Style

Before transporting, rotate discharge chute toward tow vehicle, and align slot with RED locking bar. Rotate locking bar into slot as shown and secure with lock pin.

(4) Transport Lock - Pin Style

Before transporting, pull spring lock pin down and rotate either direction until pin catches under lip as shown below left. Rotate discharge chute toward tow vehicle, and align lock pin with one of the holes located on underside of chute base plate (A). Rotate and release lock pin as shown below right, so pin engages the hole.

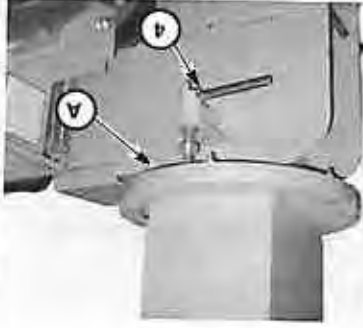

21-8 Controls

BC600XL Brush Chipper

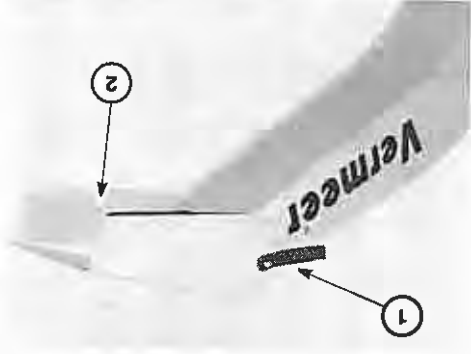
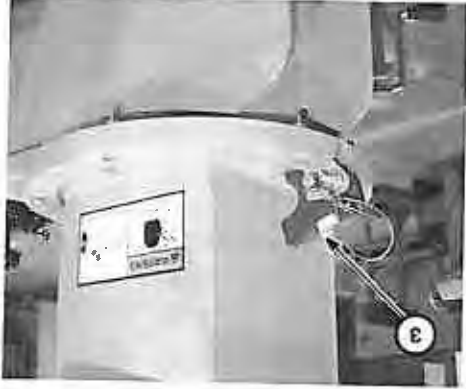

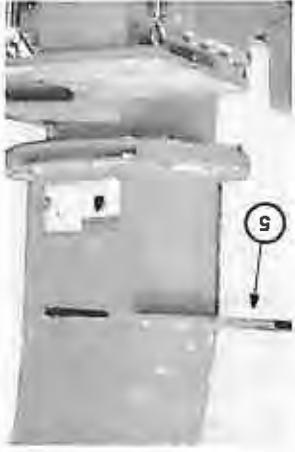
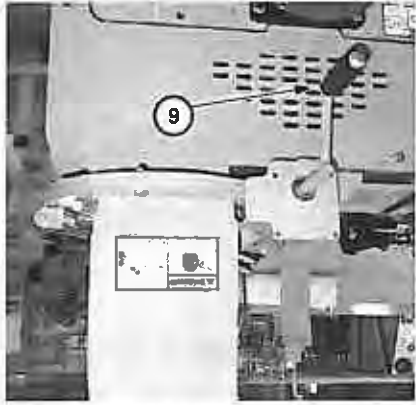

After releasing transport lock (3) or (4), use handles (5) to rotate discharge chute. If equipped, use optional handcrank (6) to rotate discharge chute.

- (5) Chute Rotation Handles
- (6) Handcrank (Option)

TONGUE JACK CONTROL - BC600XL

Use crank (1) to lower or raise machine.
To place in transport position, remove pin (2),
remove jack, and replace in horizontal position as
shown (3).



TONGUE CONTROLS - BC600XL EUROPEAN

- (1) Crank
Use crank to lower or raise jack.
- (2) Lever
Use lever to slide jack up or down.
- (3) Park Brake Lever

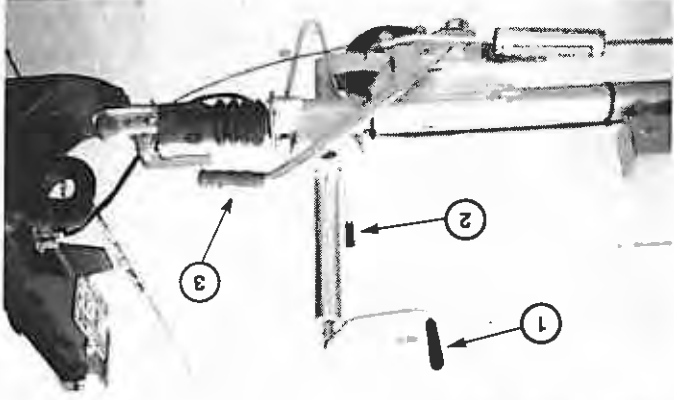

2-01

BC600XL Brush Chipper

21-10 Controls

Section 22: Starting Procedure

STARTING THE PERKINS ENGINE

IMPORTANT: Do not use ether or other starting fluids.

- Step 1: Disengage cutter disc.
- Step 2: Place *Upper Feed Control Bar* in NEUTRAL.
- Step 3: Pull *Throttle* 1/4 of the way open.
- Step 4: When engine is cold (below 35°F/1.7°C), turn key counterclockwise to turn on glow plugs and hold until preheat light shows a dull red glow (approximately 20–30 seconds).

NOTE: Do not continue heating glow plugs once the indicator shows a dull red glow, damage to glow plug will result. Using glow plugs is not necessary if engine was run earlier and is still warm.

- Step 5: Turn key fully clockwise to start engine. Release key once engine starts. If engine fails to start within 15 seconds, heat glow plugs again until preheat light shows a dull red glow.

IMPORTANT: Never run starter motor for more than 20 seconds at a time. Allow starter motor to cool 1 minute between attempts.

- Step 6: Move throttle to idle and allow engine to warm up for 4–5 minutes before engaging the cutter disc.

STARTING THE KOHLER ENGINE

- Step 1: Disengage cutter disc.

- Step 2: Place *Upper Feed Control Bar* in NEUTRAL.

- Step 3: Choke engine as necessary.

- Step 4: Set *Throttle* midway between Slow and Fast.

- Step 5: Turn key fully clockwise to start engine. Release key once engine starts.

BC600XL Brush Chipper

IMPORTANT: Never run starter motor for more than 10 seconds at a time. Allow starter motor to cool 1 minute between attempts.

Step 6: Move *Throttle* to idle and allow engine to warm up before adjusting choke and engaging cutter disc.

COLD WEATHER STARTING

Engine

Before operating in cold weather (below 32°F (0°C)), refer to the Engine Operation Manual for recommended engine oil, fuel, and starting procedures.

Hydraulic Fluid

In cold weather, take more time to warm up the hydraulic fluid. After engine is warm, let it run for a minimum of five more minutes at low RPM before operating any controls.

NOTE: Slow engine down if hydraulic pump squeals due to insufficient oil.

JUMP-STARTING

Battery Explosion - Avoid

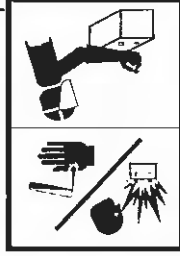

WARNING: Battery fumes are flammable and can explode. Keep all burning materials away from battery. Battery explosion can blind. Acid can blind and burn. Tools and cable clamps can make sparks.

Do not smoke. Shield eyes and face. Read instructions.

Do not jump-start or charge a battery that is frozen or low on electrolyte.

Avoid explosion hazard.

IMPORTANT: Use only a 12-volt system for jump-starting.

Do not allow vehicle used to jump-start to be in contact with the disabled machine. Vehicles in contact have a ground connection which allows a spark to occur at the battery when the positive jumper cable is connected or removed. If equipped with battery caps, they must be in place and tight to reduce risk of battery explosion.

Battery Burns - Avoid

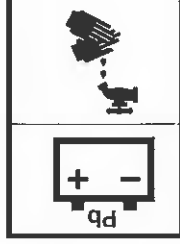

WARNING: Battery post, terminals, and related accessories contain lead and lead compounds, chemicals known to the state of California to cause cancer and reproductive harm.

Wash hands after handling.

Battery contains sulfuric acid which can cause severe burns. Avoid contact with eyes, skin, and clothing. In case of acid contact:

External: Flush with plenty of water. If eyes have been exposed, flush with water for 15 minutes and get prompt medical attention.

Internal: Drink large quantities of water or milk, follow with milk of magnesia, beaten egg, or vegetable oil. Call a physician immediately.

Jump-Starting Procedure

IMPORTANT: Review battery service safety guidelines before jump-starting machine (refer to battery maintenance instructions in the "Maintenance - 250 Service Hours" section of the *Maintenance Manual*).

Step 1: Turn ignition switch to OFF.
Step 2: Connect jumper cables in the following order:

- a. Red (1) to discharged battery POSITIVE (+) terminal.
- b. Red to booster battery POSITIVE (+) terminal.
- c. Black (2) to booster battery NEGATIVE (-) terminal.
- d. Black to frame of machine with discharged battery. Make connection away from battery, hydraulic lines, and moving parts.

NOTE: To avoid sparks near battery, always disconnect black jumper cable from booster battery before making any adjustment to red jumper cable.

Step 3: Start engine.

Step 4: Remove cables in REVERSE order and install red cover over positive cable clamp on battery.

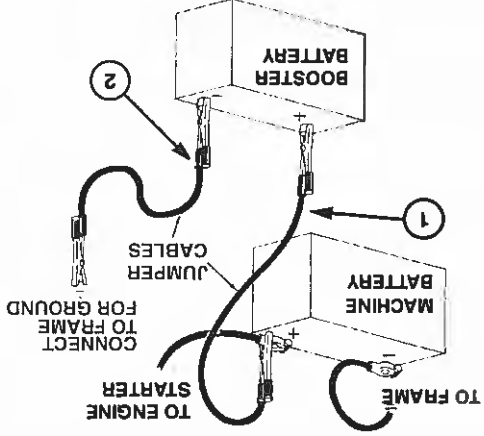

22-4 Starting Procedure

BC600XL Brush Chipper

Section 23: Shutdown Procedure

STOPPING THE MACHINE

IMPORTANT: For your safety and the safety of others, use the shutdown procedure before working on the machine for any reason, including servicing, cleaning, unclogging, inspecting, or transporting the chipper.

A variation of this procedure may be used if so instructed within this manual, or if an emergency requires it.

Step 1: Return *Upper Feed Control Bar* to **NEUTRAL**.

Step 2: Reduce engine speed to idle.

IMPORTANT: Whenever practical and consistent with good safety practice, run engine without load for a few minutes before shutting it off. This allows engine temperatures to decrease and equalize, which will increase engine life.

Step 3: Disengage belt tightener.

Step 4: Shut off engine and remove key.

Step 5: Wait for cutter disc and belt to stop.

NOTE: Cutter disc rotation can be checked by looking at the end of the shaft on the left rear side of cutter disc housing.

IMPORTANT: Cutter disc will continue to turn for a short time after engine has stopped.

Step 6: Close and latch feed table.

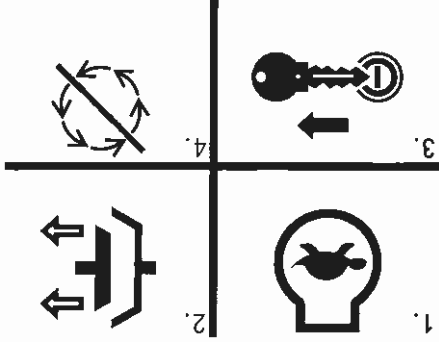

23-2 Shutdown Procedure

Quick Stop Procedure

- Step 1: Turn ignition to OFF position with belt tightener engaged and remove key.
- Step 2: Wait for cutter disc and belt to stop.
- Step 3: Disengage cutter disc.



Section 30: Transporting the Brush Chipper

REPORTING HIGHWAY TRANSPORTING SAFETY DEFECTS

If you believe that your vehicle has a defect which could cause a crash or could cause injury or death, you should immediately inform the National Highway Traffic Safety Administration (NHTSA) in addition to notifying Vermeer Corporation.

If NHTSA receives similar complaints, it may open an investigation, and if it finds that a safety defect exists in a group of vehicles, it may order a recall and remedy campaign. However, NHTSA cannot become involved in individual problems between you, your dealer or Vermeer Corporation.

To contact NHTSA, you may either call the DOT Auto Safety Hotline toll-free at 1-888-DASH-2DOT (1-888-327-4236), or file a report on-line at: www.nhtsa.dot.gov/hotline/, or write to: NHTSA, U.S. Department of Transportation, 400 - 7th St. SW, Washington, D.C. 20590. You can also obtain other information about motor vehicle safety from the Hotline.

EQUIPPING THE TOWING VEHICLE

It is recommended that the towing vehicle be equipped with mud flaps to reduce damage to the front of the towed machine from road debris.

IMPORTANT: If equipped with optional electric brakes, the towing vehicle for the BC600XL must be equipped with a brake controller that automatically applies the towed machine's electric brakes.

Do not use a brake controller that is purely a manually operated controller. If your towing vehicle is equipped with a manually operated controller, remove it and install one that can be applied both automatically and manually.

HITCH HEIGHT - ADJUST (BC600XL)

Before attaching the machine to the tow vehicle, level the machine tongue and compare the height of the hitches. They should be approximately the same height to keep the machine level during transport.

To adjust hitch height:

- Step 1: Remove two hitch-mounting bolts (1).
- Step 2: Raise or lower hitch to match towing vehicle height.
- Step 3: Replace the two hitch-mounting bolts and tighten. Torque to 80 ft-lb (108 Nm).

NOTE: There are two types of hitches available: clevis and ball.

TONGUE LENGTH - ADJUST (BC600XL)

Tongue can be lengthened or shortened to fit the towing vehicle. There are two positions that allow a 10" (25 cm) total variation in tongue length. Use the following steps to adjust tongue length:

- NOTE:** Tongue is adjusted most easily with hitch detached from towing vehicle.
- Step 1: Support machine with jack.
 - Step 2: Remove snap lock pin (1).
 - Step 3: Slide tongue (2) to the new set of holes in tongue. Align holes in tongue with holes in frame.
 - Step 4: Insert snap lock pin (1) and secure with snap lock wire.

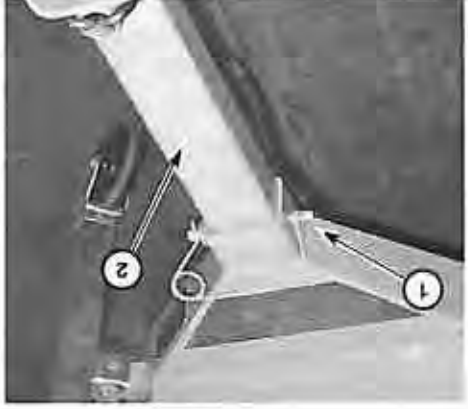

ATTACH TO TOWING VEHICLE - BC600XL

WARNING: When using a clevis hitch, the hitch pin must be locked in place with a hairpin cotter (or equivalent). Failing to lock the hitch pin in place can allow the towed machine to become unhitched from the towing vehicle.



Step 1: Securely attach machine hitch to towing vehicle. Refer to "Hitch - Ball Coupler," page 30-4 and "Hitch - Clevis," page 30-5, for instructions on specific hitch type.

Step 2: Cross safety chains (1) under tongue and attach them to the towing vehicle. Keep chains as short as possible, but leave enough slack to turn corners. If machine is equipped with optional electric brakes, attach breakaway cable to the towing vehicle bumper or frame.

IMPORTANT: Breakaway cable length should be adjusted so breakaway system applies brakes only after both hitch and safety towing chains have disconnected.

Step 4: Attach electrical connector (2) to the towing vehicle. Check that highway lights and optional electric brakes are functioning properly.

IMPORTANT: When using electric brakes, the towing vehicle must be equipped with a brake controller that automatically applies the trailer electric brakes when stopping. Step 5: Fully raise jack (3), rotate 90° and secure with attachment pin.

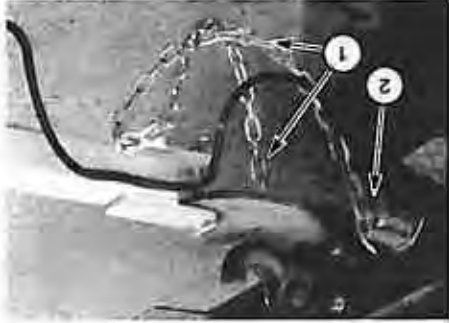

Hitch - Ball Coupler

WARNING: When using a ball coupler hitch, the clamping lip must be tightened against the ball hitch. Failing to tighten clamping lip can allow the towed machine to become unhitched from the towing vehicle.



WARNING: When using a 1-7/8" or 2" ball coupler hitch, the hitch ball diameter must be rated for greater than the towed machine GVW. Using a hitch ball that is smaller can allow the towed machine to become unhitched from the towing vehicle.



Step 1: Before using, inspect hitch components. They should be in proper working order and correctly assembled. Refer to "Maintenance - 500 Service Hours or Yearly" section in the *Maintenance Manual* for inspection information.

Step 2: Loosen loop nut (1) to allow innerspring (2) to lower clamping lip (3).
Step 3: Align towing vehicle hitch ball beneath coupler socket. Lower coupler socket over hitch ball.
Step 4: Tighten loop nut while ensuring the square head of the bolt is in the square cavity of clamping lip.

Step 5: While tightening, move the coupler up and down on the ball to ensure it is snug.

IMPORTANT: Do not use a wrench or bar to tighten coupler; hand tighten only. Overtightening strains and wears coupler parts. It may also cause coupler to seize on the ball and cause the ball nut to come loose.

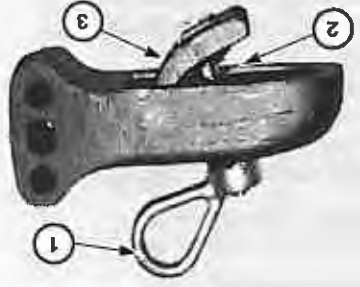

Hitch - Clevis



WARNING: When using a clevis hitch, the hitch pin must be locked in place with a hairpin cotter (or equivalent). Failing to lock the hitch pin in place can allow the towed machine to become unhitched from the towing vehicle.

To attach, back towing vehicle hitch between the clevis hitch ears, insert hitch pin through both hitches, and lock with hairpin cotter.

- (1) Hitch Pin
- (2) Hairpin Cotter

ATTACH TO TOWING VEHICLE - BC600XL EUROPEAN

- Step 1: Before attaching machine to the towing vehicle, service lock eyebolt (1) must be removed.
- Step 2: Press bottom side of the handle (2) and lift to unlock hitch.
- Step 3: Attach machine to the towing vehicle and lock handle (2) down.

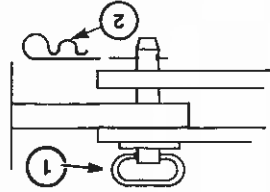
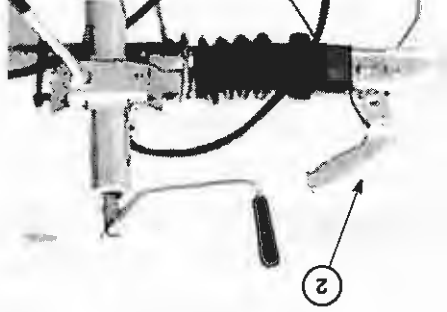
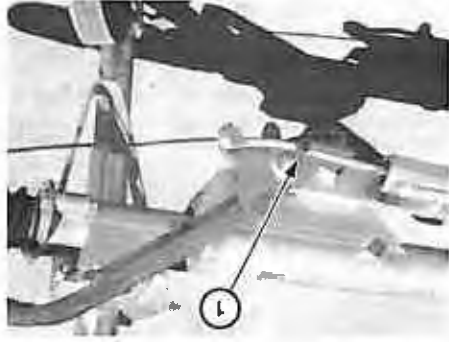

BC600XL Brush Chipper

Transporting the Brush Chipper 30-5

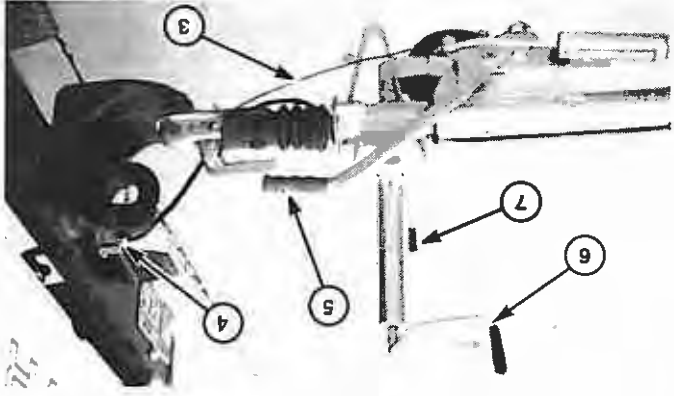

Step 4: Attach breakaway cable (3) to the towing vehicle bumper or frame.

IMPORTANT: Breakaway cable length should be adjusted so breakaway system applies brakes only after hitch has disconnected.

Step 5: Attach electrical connector (4) to the towing vehicle.

Check that highway lights are functioning properly.

Step 6: Move park brake lever (5) forward to release park brake.

Step 7: Fully raise jack (6).

Step 8: Loosen jack mount using lever (7) to slide jack up for additional clearance.

MACHINE - CLEAN BEFORE TRANSPORTING



CAUTION: Machine controls and electrical/electronic devices are not rated to withstand high pressure water and temperature power washers. Water intrusion will likely cause malfunction or damage to any devices hit directly by the water spray. Keep pressure washer stream away from machine controls and electrical/electronic devices. Compressed air can also push moisture through some connector and component seals. Do not point air nozzle directly at seal areas.

Ensure feed table is empty. Clean machine to keep debris off road and from striking other vehicles during transport.

PREPARE FOR TRANSPORT

- Step 1: Fold up feed table (1) and secure latch (2).
- Step 2: **Spring lock pin:** If equipped, pull spring lock pin (3) down and rotate either direction until pin catches under lip as shown.

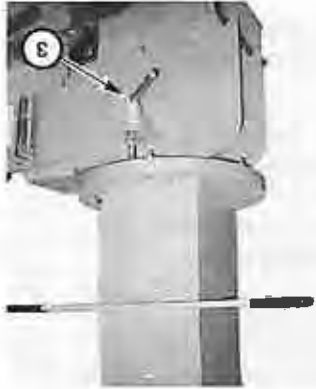

Step 3: Use handles (4) or handcrank (5) (option) to rotate discharge chute until chute faces towing vehicle.

Red lock bar: If equipped, align red locking bar (6) with slot.

Spring lock pin: If equipped, align one of the holes in chute base plate (A) with lock pin.

Step 4: **Red lock bar:** Lower locking bar (6) into slot and secure with pin as shown.

Spring lock pin: Rotate and release lock pin as shown (7), so pin engages hole.

IMPORTANT: Do not transport machine with discharge chute extending beyond sides of machine.

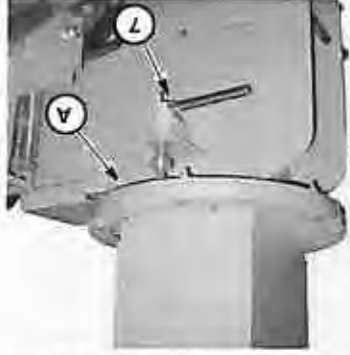
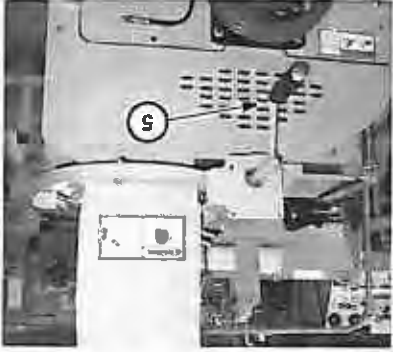
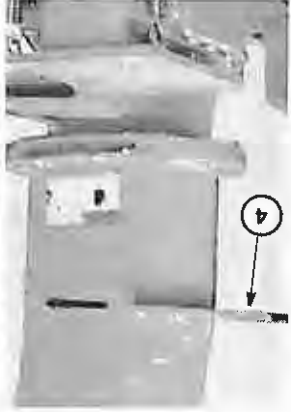

30-8 Transporting the Brush Chipper

BC600XL Brush Chipper

DETACH FROM TOWING VEHICLE

Park machine on level ground and chock wheels. Use jack to support tongue. Store electrical connector (1) and safety chains (2) on end of tongue.

On BC600XL, European machines, engage *Park Brake Lever* and use blocks (3) provided to chock wheels.

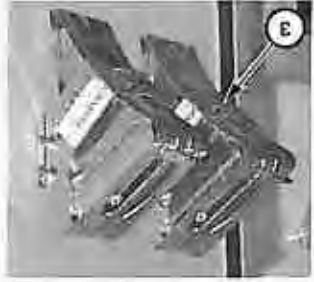
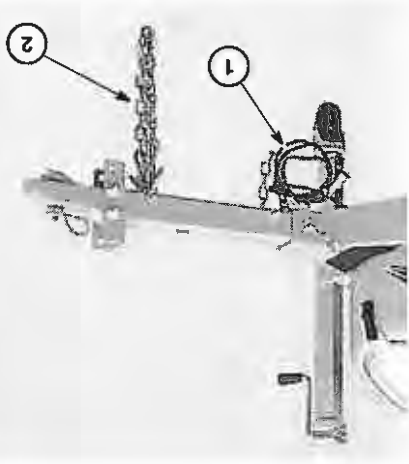

This page intentionally left blank.

Section 40: Preparing Brush Chipper and Work Area

INTENDED USE

The Vermeer BC600XL and BC600XL European Brush Chippers are designed solely for use in chipping organic material such as wood, bark, limbs, brush, and undergrowth.

Always use the machine in accordance with the instructions contained in this Operator's Manual, safety signs on the machine, and other material provided by Vermeer Corporation.

Proper maintenance and repair is essential for safety, and for efficient operation of the machine. Do not use the machine if it is not in suitable operating condition.

OPERATOR QUALIFICATIONS

WARNING: Read Operator's Manual and safety signs before operating machine.



Allow only responsible, properly instructed individuals to operate machine.

Become familiar with the controls, operation and use of the machine under the supervision of a trained and experienced operator.

The operator must be familiar with the workplace's safety rules and regulations, and must be mentally and physically capable of operating the machine safely.

PERSONAL PROTECTION



WARNING: Wear personal protective equipment. Wear close-fitting clothing and confine long hair. Avoid jewelry, such as rings, wristwatches, necklaces, or bracelets.

Operating the machine will require you to wear protective equipment. You should always wear a hard hat, safety shoes, loose-fitting gloves with narrow cuffs (guntlet-type gloves with wide cuffs are not permitted), hearing protectors, and eye protection. If working near traffic, wear reflective clothing.

Hearing protection is recommended when operating machine. Hearing protection devices provide differing levels of sound reduction. It is important to select a device that is adequate and appropriate for your specific work environment. Actual sound levels may vary widely, depending on your working conditions. To determine the level of hearing protection your work environment requires, enlist the help of your local environmental noise specialist.

Eye protection must consist of wraparound safety glasses or goggles.

Other workers in immediate area must also wear the above listed required protective equipment. Wear close-fitting clothing and confine long hair.

Avoid wearing jewelry, such as rings, wristwatches, necklaces, or bracelets.

SOUND LEVELS

The following sound levels are determined while chipping wood according to test procedures specified in EN 13525.

Equivalent Continuous A-Weighted Sound Pressure Level	at Operator's Ear (per ISO 11201).....
	$L_{Aeq} = 117$ dB(A) Kohler engine
	$L_{Aeq} = 119$ dB(A) Perkins engine
Guaranteed Sound Power Level (per 2000/14/EC, ISO 3744)	$L_{WA} = 125$ dB(A) Kohler engine
	$L_{WA} = 128$ dB(A) Perkins engine

NOTE: The stated sound levels are representative for a given operating condition. Operating conditions may vary at each jobsite. The actual sound levels for your application and operating conditions may be different.

PREPARE THE AREA

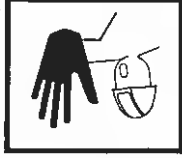

WARNING: Keep all spectators and other workers away from the machine and work area while in operation.
Never work on or near the brush chipper unless the engine is shut off and the cutter disc is stopped.



PREPARE BRUSH CHIPPER

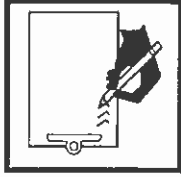

WARNING: Check machine before operating. Machine must be in good operating condition and all safety equipment installed and functioning properly.

- Survey the area around the machine for persons or obstacles before positioning the machine on the job site.
- Set up machine in an area free of obstructions that could interfere with the safe and efficient movement of the operator. Never set up beneath a tree being pruned or removed.
- Position machine so working surface of feed table is a minimum of 24" (61 cm) above ground when feeding material.
- During typical operation, brush chipper must stay hitched to the towing vehicle.
- Brush chipper may be operated while unattached to the towing vehicle if:
 - Machine is parked on a level surface.
 - Tongue and rear frame are securely supported with blocking.
 - Wheels are securely chocked.
- If operating along a road, properly warn and divert motor vehicle and pedestrian traffic. Use all necessary signs, cones, and flag persons needed for the work situation.

Clean Flammable Materials from Machine

Prevent fires by keeping engine compartment, battery, hydraulic lines, fuel tank and operator's station clean of accumulated trash, grease, and debris.

Discharge Chute

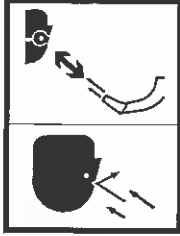

WARNING: Thrown objects can blind you.

Keep everyone away from discharge area while cutter disc is turning. Direct discharge chute away from people. Wear eye protection.

Step 1: If equipped with:

Red lock bar: Move transport red locking bar to position shown (1) and secure with pin, to enable chute rotation.

Spring lock pin: Pull spring lock pin down and rotate either direction until pin catches under lip as shown (2).

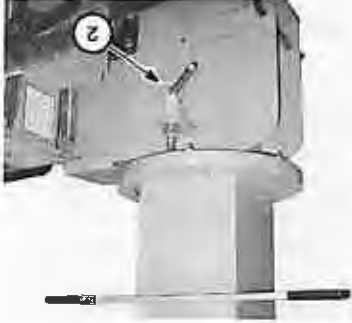

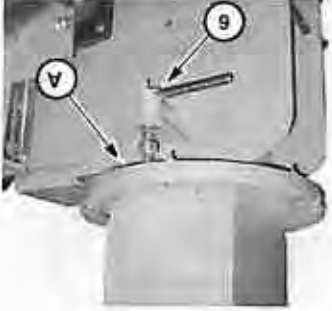
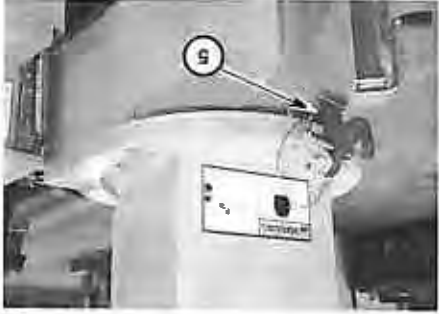

Step 2: Using handles (3) or optional crank handle (4), rotate discharge chute to the direction needed to deposit chipped material.

Step 3: If equipped with:

Red lock bar: Align red locking bar (5) with slot. Lower locking bar into slot and secure with pin as shown.

Spring lock pin: Align one of the holes in chute base plate (A) with lock pin. Rotate and release lock pin as shown (6), so pin engages hole.

Unlatch feed table (1) and lower to operating position. The feed table provides an important measure of safety by increasing the distance between the feed roller (2) and the operator. **Never** operate brush chipper with the feed table removed.

Feed Table

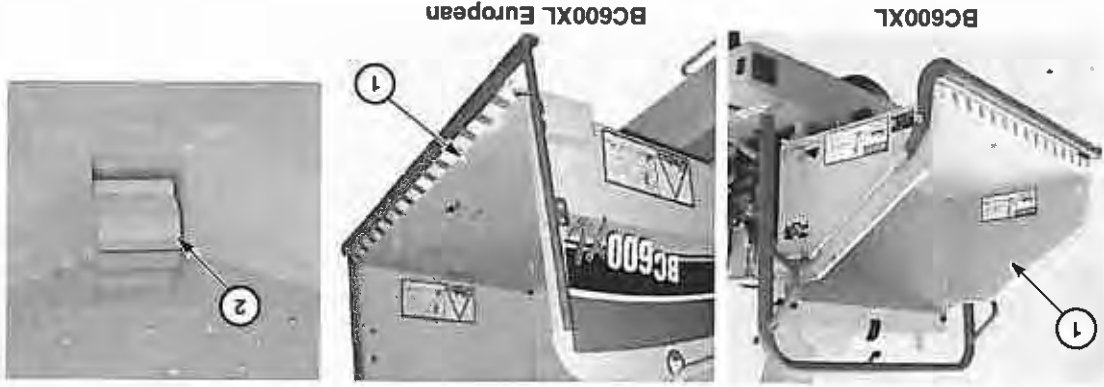

NOTE: If spout deflector and locking handles are beyond reach, position discharge chute over tongue. Stand on slip resistant material on front of machine to reach deflector.

- Step 4: Discharge chute is equipped with a stop to prevent discharging material over the feed table area. Discharge chute can be rotated 240° to direct chips to desired position.
- Step 5: To adjust discharge distance, raise or lower discharge chute deflector (7).
- Step 6: Loosen locking handles (8). Adjust deflector height. Tighten locking handles to secure adjusted deflector.

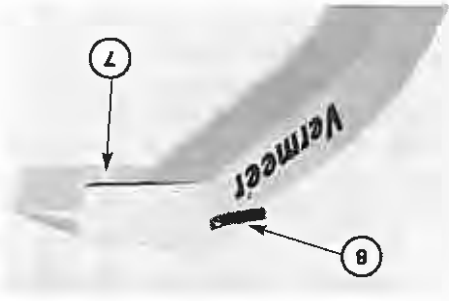
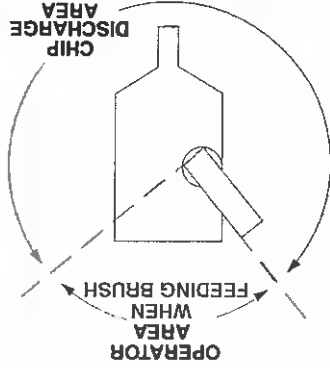

Feed Control Bars - Check

The brush chipper is equipped with an *Upper Feed Control Bar* (1) located across the top and sides of the feed table, and a *Lower Feed Stop Bar* (2) along the bottom of the feed table; also along both sides (3) of the feed table on the BC600XL European. Do not operate brush chipper unless the control bars are installed and operating properly. Refer to "Upper Feed Control Bar," page 50-3, and "Lower Feed Stop Bar," page 50-3.

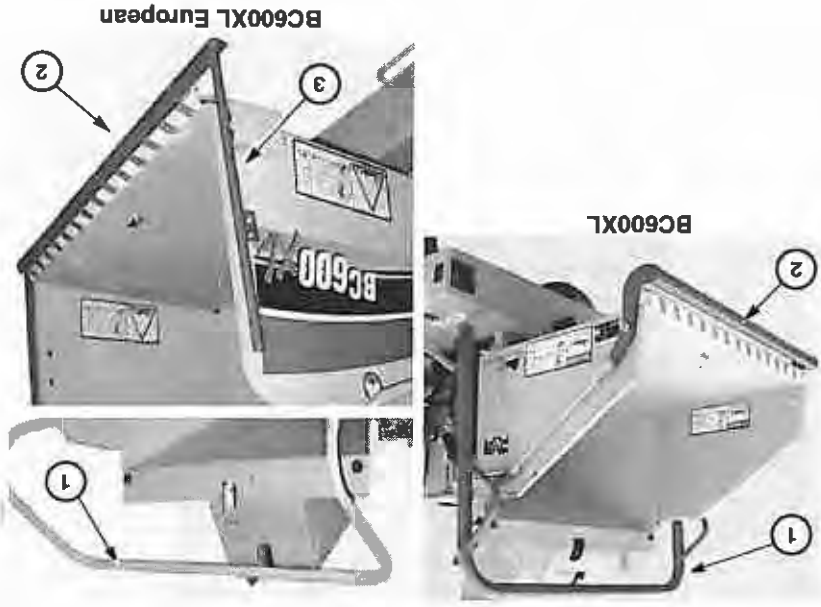

Backup Marker Flags - Install

Install flag into socket (1) on each side of machine to assist in backing at job site.
Remove flags when transporting machine.



This page intentionally left blank.

Section 50: Operating the Brush Chipper

CUTTER SHAFT - CHECK

Follow *Starting Procedure*, page 22-1, to start engine. Check cutter disc shaft end (1) to see that cutter disc does not turn while *Belt Tightener Lever* is in the **DISENGAGED** position. If adjustment is necessary, refer to the *Maintenance - 50 Service Hours or Weekly* section in the *Maintenance Manual* for instructions.

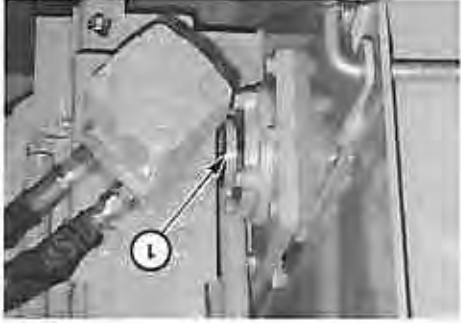

BELT TIGHTENER - ENGAGE

- Step 1: Set engine throttle slightly above idle.
 - Step 2: Grip *Belt Tightener Lever* (1) firmly and pull up and back.
 - Step 3: Engage belts slowly to avoid a sudden overload on engine.
 - Step 4: Once belt tightener is fully engaged, increase engine RPM to full throttle.
- IMPORTANT:** Do not engage belt tightener at high engine speeds. Belt life will be greatly reduced if belt tightener is repeatedly engaged at full engine speed.



FEED ROLLER OPERATION

DANGER: Limbs can snag clothing. Roller or blades can grab and pull you in faster than you can let go of limb. Cutting injury or death will result.



Never climb onto feed table.



Use wood object to push short material.



Keep away from rotating feed roller and blades.



Feed base of limb or branch first.



Wear gloves with narrow tight-fitting cuffs.



WARNING: Feed roller may start unexpectedly with a small increase in engine speed. Place *Upper Feed Control Bar* in Center Stop and stop engine before working on or near feed roller for any reason including cleaning, servicing and unclogging feed intake area.



With AutoFeed II control operation, the feed roller (1) will stop feeding material when engine RPM drops below preset speeds, and will automatically restart when engine speed increases.

IMPORTANT: Proper operation of the *Upper Feed Control Bar* and *Lower Feed Stop Bar* should be checked every 10 hours of operation or daily. Refer to the *Maintenance Manual* for adjustment instructions.

50-2 Operating the Brush Chipper

BC600XL Brush Chipper



Upper Feed Control Bar

The *Upper Feed Control Bar* (1) provides a means for the operator to quickly stop feed roller as well as selecting forward or reverse operation.

Lower Feed Stop Bar

The *Lower Feed Stop Bar* system (2) provides a means for the operator to quickly stop the feed roller if snagged by a branch and pulled toward the machine. This system is intended for your safety and must be maintained in good operating condition. Do not operate the machine if the *Lower Feed Stop Bar* is not functioning properly.

Stopping the feed roller is accomplished by bumping the *Lower Feed Stop Bar*. The *Lower Feed Stop Bar* is strategically located to make it possible for the operator's leg to strike the bar and shut off the feed roller will not stop. It is therefore very important to follow all safety instructions for feeding material into the chipper.

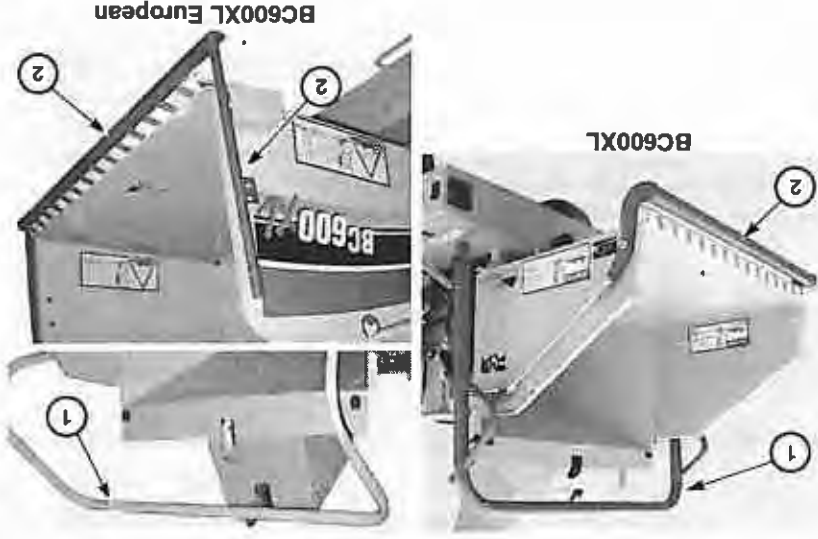

Sensitivity Levels - BC600XL Only

The *Lower Feed Stop Bar* has two levels of sensitivity:

NORMAL (*Lower Feed Stop Bar Sensitivity Lever* (3) down)—Stop bar is pushed a shorter distance before the feed roller stop.

REDUCED (*Lower Feed Stop Bar Sensitivity Lever* (3) up)—Stop bar is pushed farther before feed roller stop.

Each time the *Lower Feed Stop Bar* is engaged or the engine key is turned OFF, the *Lower Feed Stop Bar* defaults to the **NORMAL** setting.

IMPORTANT: The **NORMAL** sensitivity setting provides the most protection for the operator since a leg is more likely to strike the bar and shut off feed in an emergency. Use **NORMAL** sensitivity setting whenever job site conditions permit. If the size and shape of limbs cause branches to strike the bar, resulting in an unacceptable frequency of feed stops, the **REDUCED** sensitivity setting may be temporarily selected. When these difficult conditions have passed, select the **NORMAL** setting to continue chipping.



Feed Roller - Engage

Step 1: Pull *Upper Feed Control Bar* (1) to the FORWARD feeding position to start feed roller.

Step 2: **BC600XL:** Pull *Reset Lever* (2) back. **BC600XL European:** If amber indicator light on *Reset Switch* (3) is lit, press top of switch (3).

Step 3: Adjust *Feed Roller Speed Control* (4) as needed.

If material continues to strike the bar and stop the feed roller, trim or shorten material before feeding it into the chipper.

NOTE: Each time the feed table is put into the stop position, the feed system defaults to the tripped (STOP) position.

NOTE: Engine throttle must be set at HIGH RPM before feed roller will start.

Autofeed II Control Operation (Option)

Autofeed II control is always ON and is actuated automatically.

With Autofeed II control operation, the feed roller will stop feeding material when engine RPM drops below preset speeds, and will automatically restart when engine speed increases.

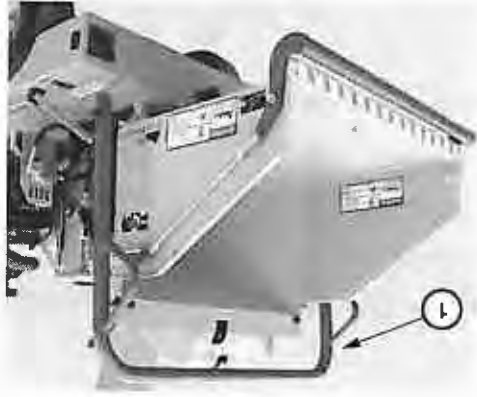

BC600XL

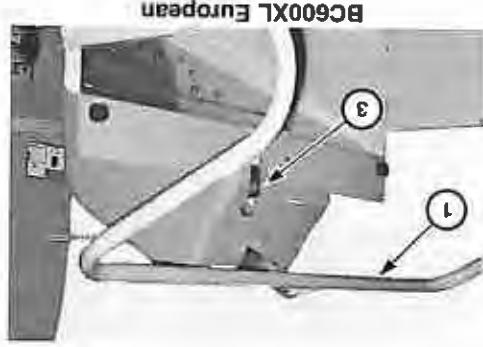

BC600XL European

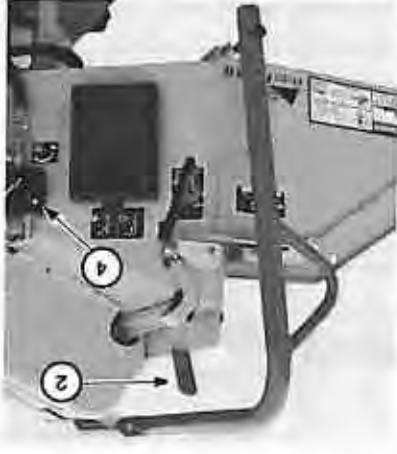

CHIP MATERIAL

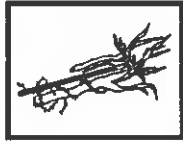

WARNING: Check material being chipped. Avoid stones, wire, or other objects which may damage the knives and become dangerous projectiles.

Feeding Tips

- If feeding material by hand, always feed from the side of infeed chute; never directly behind it.
- Feed large end of log or branch into chipper first.
- To stay out of traffic while operating along a road, feed material from curb side.
- If feeding brushy material that frequently catches on *Lower Feed Stop Bar* and stops the feed roller, change sensitivity setting to REDUCED sensitivity (applies to BC600XL only).
- Sometimes during feeding, a limb will suddenly turn or move sideways and may strike you. To reduce the possibility of being struck, release the limb immediately after it begins feeding and then turn away.

Material Size

- Brush chipper will chip logs approximately 6" (15 cm) in diameter.
- Sometimes a log, due to its size and shape, will not go in. Trim or shorten logs to aid feeding into chipper.

Plugs or Stalls

- If discharge chute, cutter disc, or feed roller becomes plugged during operation, refer to *Removing Plugs from Brush Chipper, page 51-1*, for more information.
- If engine stalls while chipping, return *Upper Feed Control Bar* to STOP and disengage belt tightener.

50-6 Operating the Brush Chipper

2_01

BC600XL Brush Chipper

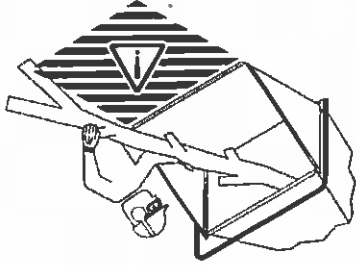

- ### Finishing
- With belt tightener disengaged, start engine and throttle up to full speed. Reverse feed roller to remove material that caused the stall.
 - Return engine speed to near idle before engaging belt tightener and resuming chipping operation.

- Chipped material that accumulates in the infeed chute can be pulled into the machine by feeding in a piece of brush, or by pushing it in with a long limb. **Never** push chipped material with hands, feet, rake, shovel, or any other object.
- When chipping operation is complete, follow *Shutdown Procedure*, page 23-1.

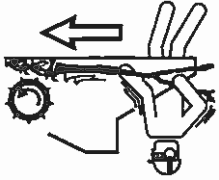

This page intentionally left blank.

Section 51: Removing Plugs from Brush Chipper

FEED ROLLER - UNPLUG

DANGER: Do not rely upon the *Lower Feed Stop Bar* to protect you from being pulled into the brush chipper. Limbs can snag clothing. Roller or blades can grab and pull you in faster than you can let go of limb. Cutting injury or death will result.

Never climb onto feed table.

Use wood object to push short material.

Keep away from rotating feed roller and blades.

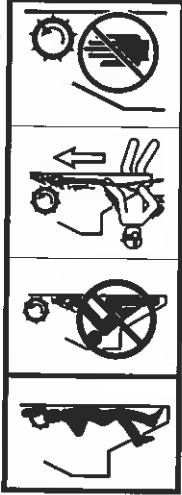

BC600XL Brush Chipper

Removing Plugs from Brush Chipper 51-1

If feed roller becomes plugged, reverse feed roller with *Upper Feed Control Bar (1)*. Inspect dislodged material, ensuring it is not too large or has branches that prevent it from being fed into the machine. If reversing feed roller does not dislodge the plug, the cutter disc housing needs to be opened and plug removed from feed roller. Refer to the "Cutter Disc Housing - Open," *page 51-4* instructions, and remove any wood that is lodged in feed roller.

51-2 Removing Plugs from Brush Chipper

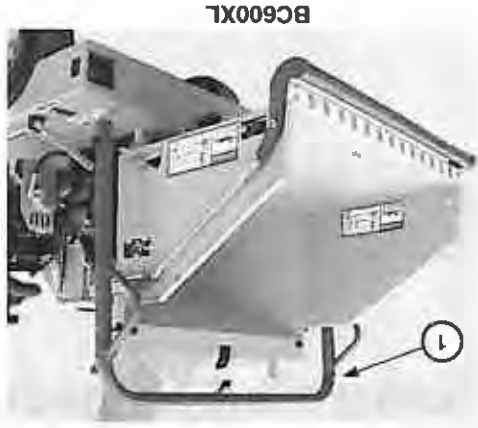

BC600XL Brush Chipper

CUTTER DISC ROTATION - CHECK

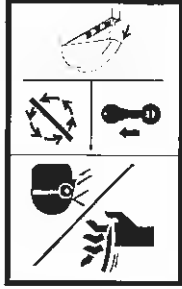

WARNING: Rotating knives under cover can cut off hand.
Thrown objects can strike you.

Stop engine, wait for disc to stop, then open access cover.

Step 1: Follow *Shutdown Procedure*, page 23-1 and shut down machine.

Step 2: Wait for cutter disc to fully stop.

Step 3: Check cutter disc rotation by looking at end of shaft (1) on side of cutter disc housing.



CUTTER DISC HOUSING - OPEN

WARNING: Never start engine and engage cutter disc while cutter disc housing is open. Contact with cutter disc will cause serious injury. Ejected material can cause injury and blindness.



IMPORTANT: Swing discharge chute over right side of machine and secure with locking bar before removing access cover bolts (1). If discharge chute is turned out over the left side of machine, the cover and chute could drop suddenly after chute locking pin (2) is removed.

Step 1: Remove two bolts (1) securing access cover.

Step 2: Support discharge chute while removing chute locking pin (2).

Step 3: Lower chute and cutter disc cover (3) to full open position.

IMPORTANT: Wear gloves when working near cutter disc knives. When removing chips, keep hands away from the sharp knives.

Step 4: Remove chips and plugs from cutter disc housing and discharge chute.

- Check cutter disc housing. Pull on a cutter disc paddle or grip the edge of cutter disc, away from the knife, and reverse disc rotation to dislodge the plug, making it easier to remove chips.
- Check discharge chute and clean out if plugged.

NOTE: A significant amount of chips left in cutter disc area will quickly re-plug cutter disc.

Step 5: Close and bolt access cover.

Step 6: Reinstall locking pin (2).

51-4 Removing Plugs from Brush Chipper

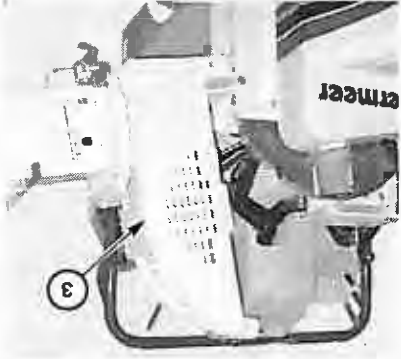
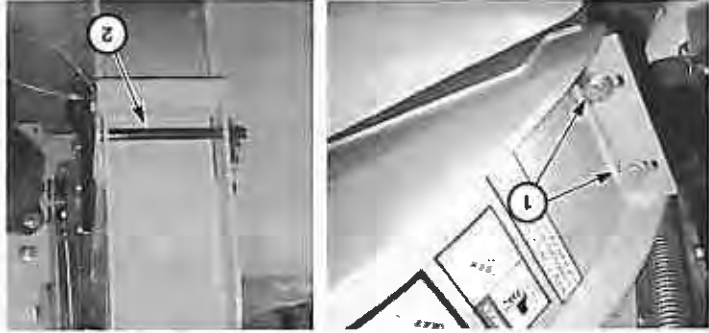

BC600XL Brush Chipper

Step 7: Operate machine without chipping additional material, to blow out chips that remain in the housing or discharge chute.

CUTTER DISC - UNPLUG

- Step 1: Disengage belt drive, shut off engine, refer to *Shutdown Procedure*, page 23-1, and wait for cutter disc to stop before opening cutter disc housing.
- Step 2: Open cutter disc housing, refer to the "Cutter Disc Housing - Open," page 51-4 instructions, and check to see if a cutter disc knife is lodged in the wood.
- Reverse disc rotation to dislodge knife by pulling on a cutter disc paddle or gripping the edge of cutter wheel, away from knife.
- Using a pry bar, move the lodged wood rearward enough to allow room for knives to pass by.
- Step 3: Close and bolt access cover.

This page intentionally left blank.

Section 60: Maintenance Intervals

WARNING: Use Shutdown Procedure before servicing, cleaning, repairing or transporting machine. Refer to the *Shutdown Procedure*, page 23-1, for instructions.

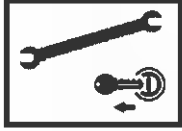

Visually inspect machine daily before starting the machine.

Make no modifications to your equipment unless specifically recommended or requested by Vermeer Corporation.

HOURMETER - CHECK FOR MAINTENANCE INTERVAL

The hourmeter on the power unit is designed to determine maintenance intervals for the machine. The hourmeter indicates the total number of hours the engine has been in operation.

Maintenance intervals are based on normal operating conditions. When operating under severe conditions, the maintenance intervals should be shortened.

MACHINE - GREASE

As a general rule, grease machine after it is shut down for the day. This protects metal under seals from corrosion caused by condensation as temperature drops.

Ensure all fittings and nozzle of grease applicator are clean before applying grease. If any grease fittings are missing, replace them immediately.

SAFETY SIGNS

Safety signs located on your machine contain important and useful information that will help you operate your equipment safely. Refer to the *Parts Manual and Controls, page 21-1* for locations.

To assure that all safety signs remain in place and in good condition, follow the instructions given below:

- Keep safety signs clean. Use soap and water - not mineral spirits, abrasive cleaners, or other similar cleaners that will damage the sign.

- Replace any damaged or missing safety signs. When attaching signs, the temperature of the mounting surface must be at least 40°F (5°C). The mounting surface must also be clean and dry.
- When replacing a machine component with a safety sign attached, replace safety sign also.
- Replacement safety signs can be purchased from your Vermeer equipment dealer.
- Replace any damaged or missing anti-slip material.































































































































































































MAINTENANCE MANUAL

Maintenance intervals are included for reference only. Before performing any maintenance, refer to the *Maintenance Manual* for safety guidelines and correct procedures.

This page intentionally left blank.

Section 61: Knife/Cutter Disc Maintenance

Recommended service interval for cutter knives is 10 service hours. However, the actual service hours interval before knife maintenance is required may be more or less, depending upon the wood being chipped and chipping conditions.

 <p>WARNING: Rotating knives under cover can cut off hand. Thrown objects can strike you.</p>																																																																																																																																																																																															
---	---	---	---	---	---	---	---	---	---	---	---	---	---	---	---	---	---	---	---	---	---	---	---	---	---	---	---	---	---	---	---	---	---	---	---	---	---	---	---	---	---	---	---	---	---	---	---	---	---	---	---	---	---	---	---	---	---	---	---	---	---	---	---	---	---	---	---	---	---	---	---	---	---	---	---	---	---	---	---	---	---	---	---	---	---	---	---	---	---	---	---	---	---	---	---	---	---	---	---	---	---	---	---	---	---	---	---	---	---	---	---	---	---	---	---	---	---	---	---	---	---	---	---	---	---	---	---	---	---	---	---	---	---	---	---	---	---	---	---	---	---	---	---	---	---	---	---	---	---	---	---	---	---	---	---	---	---	---	---	---	---	---	---	---	---	---	---	---	---	---	---	---	---	---	---	---	---	---	---	---	---	---	---	---	---	---	---	---	---	---	--

WARNING: Never start engine or operate machine with the cutter disc housing open. Thrown objects and contact with cutter disc will result in serious injury.



Performing the following maintenance procedures will aid in reducing the possibility of knives becoming loose, failing, and being ejected from the machine.

KNIFE REMOVAL

IMPORTANT: Wear glove when working with the cutter disc knives. Serious cutting injuries will result if contact is made with the knives while removing or installing them.

IMPORTANT: Always remove and replace knives as sets. Chipper balance can be affected if matched knives are not kept together. It is important to keep knives sharpened and properly adjusted.

To remove knives:

IMPORTANT: Swing discharge chute over the right side of machine and secure with locking bar before removing access cover bolts. If discharge chute is turned out over the left side of machine, the cover and chute could drop suddenly after chute locking pin is removed.

Step 1: Remove two bolts (1) securing access cover.

Step 2: Support discharge chute while removing chute locking pin (2).

61-2 Knife/Cutter Disc Maintenance

BC600XL Brush Chipper

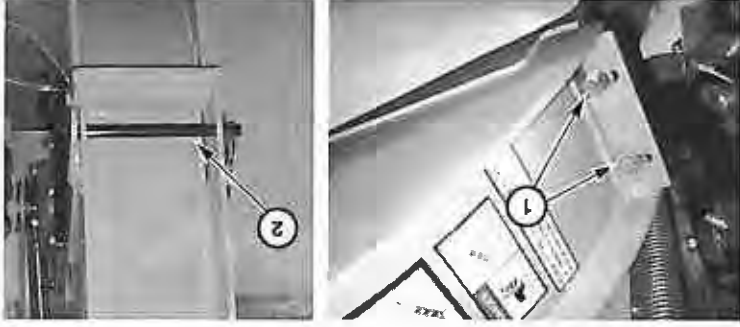

Step 3: Lower chute and cutter disc cover (3) to full open position.

Step 4: Lock cutter disc to prevent it from rotating while working on knives.

Align one of the two lock holes in cutter disc with lock pin (4) and secure with hairpin cotter.

Step 5: Remove three bolts (A), hardened washers (C), nuts (D), and backing plate (E) from first knife (B). Lift

off knife from disc.

Step 6: Unlock cutter disc and rotate 1/2 turn to the outside surface of disc. Rotate by pushing on the outside surface of disc.

Step 7: Lock cutter disc.

Step 8: Repeat Step 4 and remove other knife.

Step 9: Inspect bolts, washers, and nuts for damaged threads or cracks. Replace as necessary.

Cutter Disc Inspection

Cutter disc must be free of any damage. Thoroughly clean and inspect cutter disc surface for cracks that may begin at the mounting holes and migrate outward. If any cutter damage or cracks are found, contact an authorized independent Vermeer dealer.

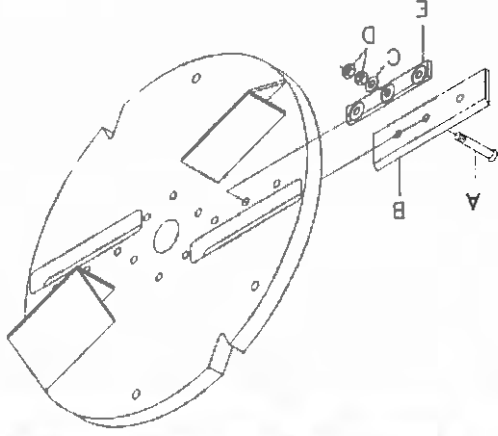
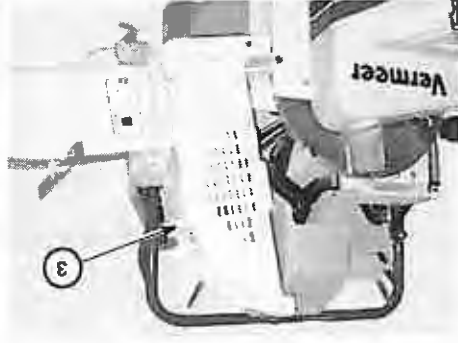

Knife Sharpening

- Sharpen knives at a 40° angle.
 - Use a soft "J" grade grinding disc with 36 to 46 grit.
 - Use adequate coolant while grinding.
 - Hone knives between sharpenings with an oil honing stone.
- IMPORTANT:** Do not use a knife which has been sharpened past a minimum width of 2-1/2" (64 mm).

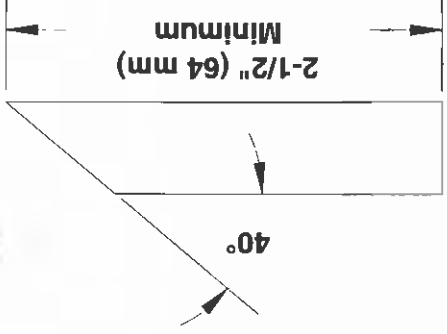

Knife Installation

Step 1: Clean and inspect all cutter disc components as per the preceding instructions.

Step 2: Lock cutter disc.

Step 3: Install knife (B) with the bevel oriented as shown.

NOTE: Backing plate is tapered to allow hardened washers and nuts to seat flat on backing plate. Be careful to install this plate correctly as shown. If installed incorrectly, premature bolt failure could occur.

Step 4: Lubricate bolts (A) with light oil and install backing plate (B), hardened washer (C), and one nut (D).

Step 5: Lightly tighten first nut on each bolt to hold knife in place. Ensure all bolt heads are centered in the knife holes and that hardened washers and nuts seat flat on backing plate.

Step 6: Torque nuts to 180 ft-lb (244 Nm) beginning with the center bolt. Recheck torque on all nuts after the last nut is tightened. Do not overtorque nuts.



WARNING: Overtightened bolts can cause knife distortion, allowing wood to pack under knife. Distorted knives can crack and fail resulting in death or serious injury, and machine damage. Use a straightedge and check all knives for distortion; discard any that are distorted.

Step 7: Install second nut on each bolt and torque to 60 ft-lb (80 Nm). Recheck torque of all three nuts after the last nut is tightened. Do not overtighten. Do not torque nuts.

IMPORTANT: Do not tighten second nut beyond 60 ft-lb (80 Nm). Overtightening nuts could cause bolts to fail.

Step 8: Unlock cutter disc and rotate 1/2 turn to the next cutter knife.

Step 9: Lock cutter disc.

Step 10: Repeat Steps 3–7 to install the second knife.

Step 11: After both knives are changed or turned, the shear bar will need to be adjusted (refer to the *Maintenance Manual, Maintenance - 50 Service Hours or Weekly section*, “Shear Bar - Check/Adjust”).

IMPORTANT: The shear bar bolts must be checked weekly, even if you do not need to adjust or replace the shear bar. Refer to the *Maintenance Manual, Maintenance - 50 Service Hours or Weekly section*, “Shear Bar - Check/Adjust”.

Step 12: Remove cutter disc lock pin.

Step 13: After shear bar adjustment is complete, close access cover and reinstall bolts and cutter disc housing lock pin (1) as shown.



This page intentionally left blank.

INDEX

A	Attach to Towing Vehicle - BC600XL, 30-3; EU, 30-5	
B	AutoFeed II Control Operation (Option), 50-5	
	Backup Marker Flags - Install, 40-9	
	Battery Burns/Explosion - Avoid, 22-3	
	Belt Tightener - Engage, 50-1	
C	Chip Material, 50-6	
	Clean Flammable Materials from Machine, 40-4	
	Controls, 21-1	
	Cutter Disc - Unplug, 51-5	
	Cutter Disc Controls, 21-4	
	Cutter Disc Housing - Open, 51-4	
	Cutter Disc Inspection, 61-3	
	Cutter Disc Rotation - Check, 51-3	
	Cutter Shaft - Check, 50-1	
D	Dealer Prep, !	
	Dealer/Customer Information, iv	
	Delivery, iii	
	Detach from Towing Vehicle, 30-9	
	Discharge Chute Controls, 21-8	
	Discharge Chute, 40-5	
	BC600XL Brush Chipper	2_05
		2_04
		2_02
E	Engine Controls - Kohler, 21-3	
	Engine Controls & Monitors - Perkins (EU Only), 21-1, 21-2	
	Engine, 22-2	
	Equipping the Towing Vehicle, 30-1	
F	Feed Control Bars - Check, 40-8	
	Feed Roller - Engage, 50-5	
	Feed Roller - Unplug, 51-1	
	Feed Roller Controls, 21-5	
	Feed Roller Operation, 50-2	
	Feed Table, 40-7	
	Feeding Tips, 50-6	
	Finishing, 50-7	
	Fluid Monitors, 21-4	
G		
H	Hitch - Ball Coupler, 30-4	
	Hitch - Clevis, 30-5	
	Hitch Height - Adjust (BC600XL), 30-2	
	Hourmeter - Check for Maintenance Interval, 60-1	
	Hydraulic Fluid, 22-2	
I	Intended Use, 40-1	

Prepare for Transport, 30-7
Prepare the Area, 40-3
Preparing Brush Chipper and Work Area, 40-1

Q
Quick Stop Procedure, 23-2

R
Removing Plugs from Brush Chipper, 51-1
Reporting Highway Transporting Safety Defects, 30-1
Review of Operation, !!!

S
Safety Messages, 10-1
Safety Signs, 60-2
Safety Symbol Explanation, 10-1
Shutdown Procedure, 23-1
Sound Levels, 40-3
Starting Procedure, 22-1
Starting the Kohler Engine, 22-1
Starting the Perkins Engine, 22-1
Stopping the Machine, 23-1

T
Tongue Controls - BC600XL European, 21-10
Tongue Jack Control - BC600XL, 21-10
Tongue Length - Adjust (BC600XL), 30-2
Transporting the Brush Chipper, 30-1

U
Upper Feed Control Bar, 50-3

J
Jump-Starting, 22-3, 22-4

K
Knife Installation, 61-4
Knife Removal, 61-2
Knife Sharpening, 61-4
Knife/Cutter Disc Maintenance, 61-1
Kohler Engine - Record, 1-vi

L
Lower Feed Stop Bar, 50-3

M
Machine - Clean Before Transporting, 30-6
Machine - Grease, 60-1
Machine Identification Numbers - Record, v

Maintenance Intervals, 60-1, 60-3
Maintenance Manual, 60-2
Material Size, 50-6

N
Operating the Brush Chipper, 50-1
Operator Qualifications, 40-1

P
Personal Protection, 40-2
Plugs or Stalls, 50-6
Prepare Brush Chipper, 40-4

Index

WARNING



The engine exhaust from this product contains chemicals known to the State of California to cause cancer, birth defects, or other reproductive harm.

CALIFORNIA

Proposition 65 Warning

Diesel engine exhaust and some of its constituents are known to the State of California to cause cancer, birth defects, and other reproductive harm.

When operated in California, any off-road diesel vehicle may be subject to the California Air Resources Board In-Use Off-Road Diesel Vehicle Regulation. It therefore could be subject to retrofit or accelerated turnover requirements to reduce emissions of air pollutants. For more information, please visit the California Air Resources Board website at <http://www.arb.ca.gov/msprog/ordiesel/ordiesel.htm>.

Copyright 2005, 2008, 2009. All rights reserved.
Vermeer Corporation
1210 Vermeer Road East, P.O. Box 200
Pella, Iowa 50219-0200